

1A, 50V - 600V Surface Mount Super Fast Rectifiers

FEATURES

- Glass passivated junction chip
- Ideal for automated placement
- Super fast recovery time for high efficiency
- Built-in strain relief
- Compliant to RoHS Directive 2011/65/EU and in accordance to WEEE 2002/96/EC
- Halogen-free according to IEC 61249-2-21 definition

MECHANICAL DATA

Case: SOD-123FL

Molding compound, UL flammability classification rating 94V-0

Moisture sensitivity level: level 1, per J-STD-020

Terminal: Matte tin plated leads, solderable per JESD22-B102

Meet JESD 201 class 2 whisker test

Polarity: Indicated by cathode band

Weight: 0.01 g (approximately)

SOD-123FL

Unit : inch(mm)

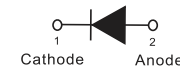
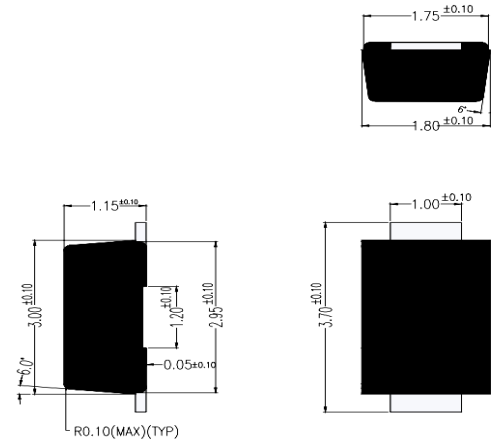

MAXIMUM RATINGS AND ELECTRICAL CHARACTERISTICS (T _A =25°C unless otherwise noted)										
PARAMETER	SYMBOL	ES 1000 FL	ES 1001 FL	ES 1015 FL	ES 1002 FL	ES 1003 FL	ES 1004 FL	ES 1005 FL	ES 1006 FL	UNIT
Maximum repetitive peak reverse voltage	V _{RRM}	50	100	150	200	300	400	500	600	V
Maximum RMS voltage	V _{RMS}	35	70	105	140	210	280	350	420	V
Maximum DC blocking voltage	V _{DC}	50	100	150	200	300	400	500	600	V
Maximum average forward rectified current	I _{F(AV)}	1								A
Peak forward surge current, 8.3 ms single half sine-wave superimposed on rated load	I _{FSM}	30								A
Maximum instantaneous forward voltage (Note 1) @ 1 A	V _F	0.95			1.3		1.7			V
Maximum reverse current @ rated V _R	I _R	5								μA
		100								
Maximum reverse recovery time (Note 2)	t _{rr}	35								ns
Typical junction capacitance (Note 3)	C _J	16				18				pF
Typical thermal resistance	R _{θJL} R _{θJA}	35 85								°C/W
Operating junction temperature range	T _J	- 55 to +150								°C
Storage temperature range	T _{STG}	- 55 to +150								°C

Note 1: Pulse test with PW=300μs, 1% duty cycle

Note 2: Reverse Recovery Test Conditions: I_F=0.5A, I_R=1.0A, I_{RR}=0.25A

Note 3: Measured at 1 MHz and Applied V_R=4.0 Volts

RATINGS AND CHARACTERISTICS CURVES

($T_A=25^\circ\text{C}$ unless otherwise noted)

FIG.1 MAXIMUM FORWARD CURRENT DERATING CURVE

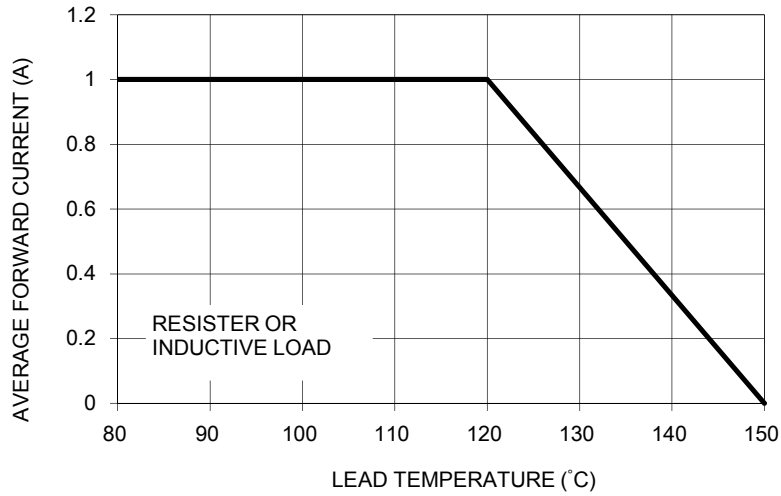

FIG. 2 TYPICAL INSTANTANEOUS FORWARD CHARACTERISTICS

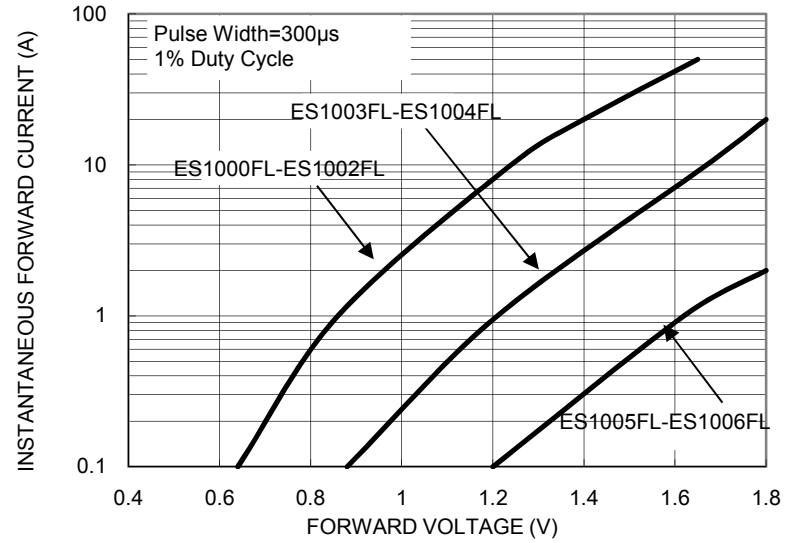

FIG. 3 MAXIMUM NON-REPETITIVE FORWARD PEAK SURGE CURRENT

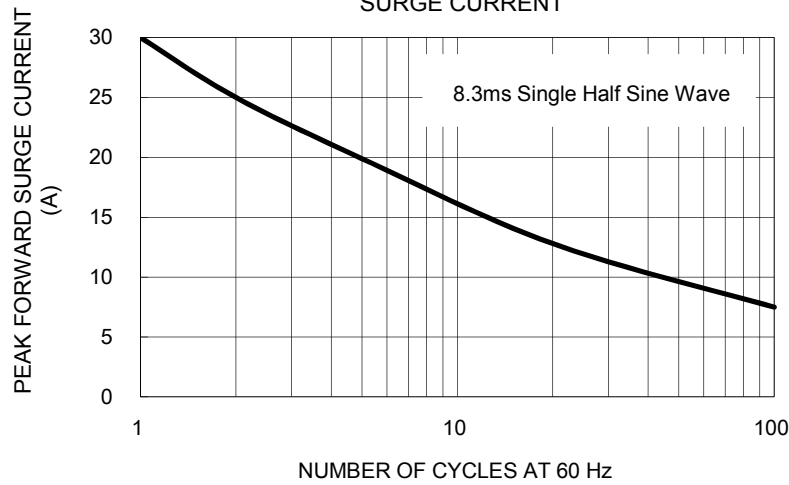

FIG. 4 TYPICAL REVERSE CHARACTERISTICS

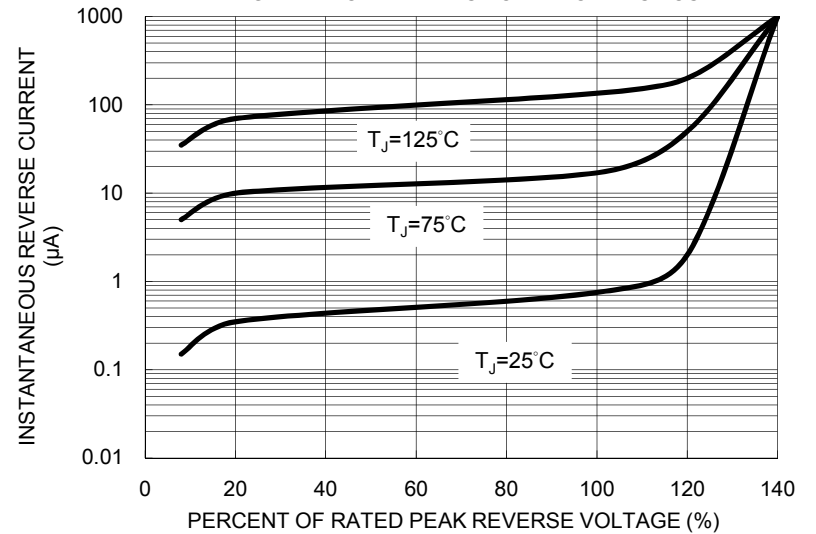

FIG. 5 TYPICAL JUNCTION CAPACITANCE

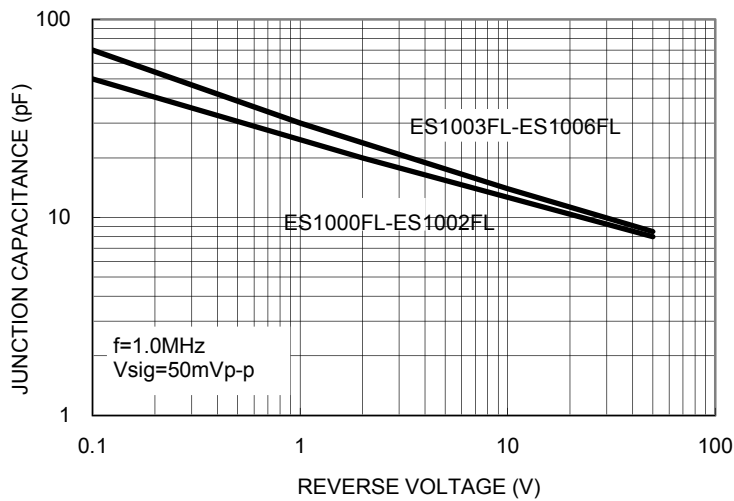

FIG.6- REVERSE RECOVERY TIME CHARACTERISTIC AND TEST CIRCUIT DIAGRAM

